

# Accessories



P.O. Box 157 • W142 N9110 Fountain Blvd.  
 Menomonee Falls, WI 53052-0157  
 (888) 719-7599 Toll-free • (262) 250-7599  
 (262) 250-7598 Fax  
 e-mail: info@concretepoles.com • www.concretepoles.com

## Arms

Each is available in 4', 6', and 8' lengths

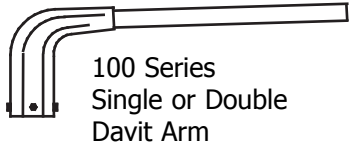

100 Series  
Single or Double  
Davit Arm

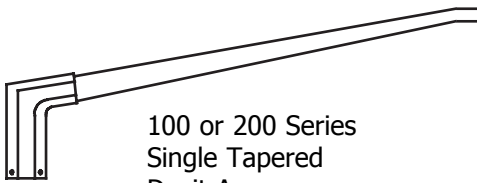

100 or 200 Series  
Single Tapered  
Davit Arm

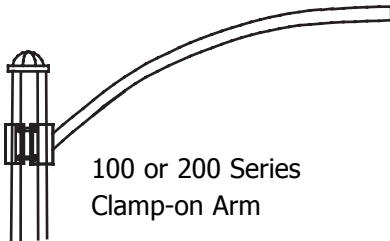

100 or 200 Series  
Clamp-on Arm

## Banner Arms

This Banner Arm\* kit includes two 31" banner arms, banding, and a face-plate kit. Everything you need to mount your banner on a pole up to 9" in diameter. Double Banner Arm kits are also available.

Note: If you purchase a Quick-Chore mounting kit, you will need a Band-it Tool to attach your banner arms to the pole.

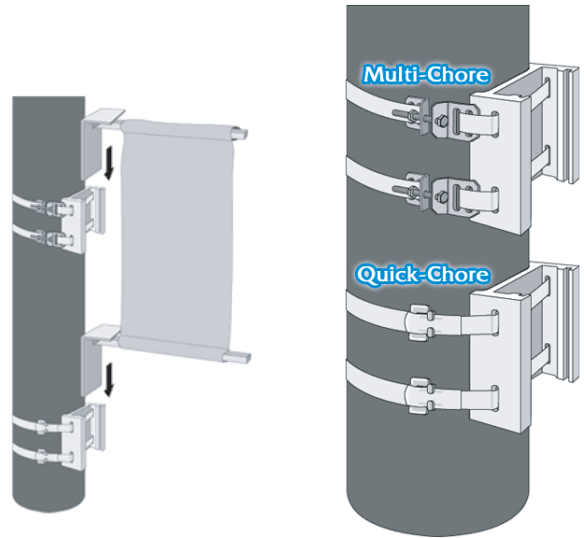

\* Manufactured by Liberty/World Class Flags  
 Direct inquiries to 1.800.274.7001  
[www.worldclassflags.com](http://www.worldclassflags.com)

## Bull Horns

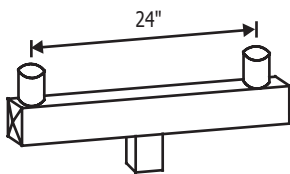

Bull Horn 2

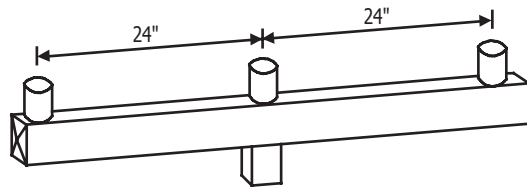

Bull Horn 3

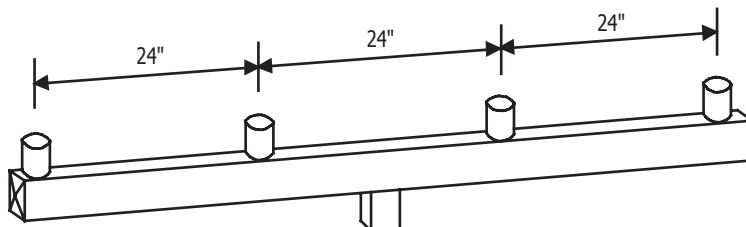

Bull Horn 4